

AIRSOFT GUN INSTRUCTION MANUAL

使用說明書

GYMA

AIRSOFT ELECTRIC SPRING GUN
AUTOMATIC FIRING

電動汽彈槍
自動射擊

Users restricted to
18 years of age or older
使用年齡對象**18**歲以上



CM.022

在操作之前或照這些說明書

Always read through this manual before operation.

 警告 WARNING	
 18歲以上年齡才能使用 Only for 18 years of age or older.	18歲以上年齡才能利用這支汽槍比賽使用 Operation of this air gun for competition use is restricted to users of 18 years of age or older.
 注意避球槍 Injury caution	因為BB彈能達到60-65米距離, 不小心射擊可能會導致眼睛受傷或其他傷害。 Since plastic BB bullets reach 60 to 65 meters, careless shooting may cause eye damage or other injuries.
 注意請認真閱讀說明書 Careful reading of Handling cautions and instruction manual	在操作之前要細心讀過警告書和指示手冊操作汽槍時必須認明這些警告。 Always read through this HANDLING CAUTION AND INSTRUCTION MANUAL carefully before operation. Operate the air gun with full recognition of warnings and cautions.

Please read the instructions carefully before use.
(Please read the Notice in details.)
Please retain the instructions for future reference
Don't use it improperly or refit the air gun.

使用前請先完整閱讀說明書
(注意部份請詳細閱讀)
保存好此說明書以供日後使用參照
切勿錯誤使用或改裝汽彈槍



WARNING 警告



Certified shooting safety goggles
合格的發射防護眼鏡。
Wear protective eye wear & face mask when using air soft airguns.

當使用汽彈槍時，請戴上防彈眼鏡和面具。

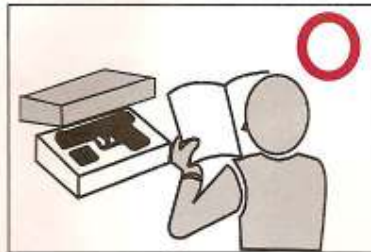

Read and understand the operating and safety manual before using your air soft airguns.

在使用汽彈槍前，請先閱讀和理解操作安全手冊。



Do not look directly into the gun barrel to avoid accidental discharge of BB.

不要直接地看槍管，避免BB彈意外發射。



You may be punished if you damage public or personal properties or injure a person or animal even if you are shooting for a practical joke. Always observe manners and enjoy healthy sport shooting.

如果你損害公共的或私人的財產，或者傷害人或動物，即使你是在進行射擊實踐遊戲，你也會受到懲罰。請始終遵守規矩，享受有益健康的運動射擊。



Never aim or shoot a person or animal as the target. Always attach the protective plug to the muzzle, except when you are ready to shoot a target.

不可把人或動物當作目標瞄準或射擊。始終系上槍口的防護塞，除非你準備去射擊一個明確的目標。



This air gun is manufactured under consideration of appropriate performance and operability. Disassembling or modifying the gun may generate danger or adversely affect the performance. So, avoid disassembling or modifying the air gun.

該氣槍是根據適當的性能和操作性而製造的。拆除或改裝氣槍可能產生危險或者逆反操作。因此要避免拆除或改裝該氣槍。

THE NAME OF THE PARTS 各部件名稱



7.2V rechargeable battery 7.2V充電電池 ×1

Loader 裝彈器 ×1

Unloader 清彈器 ×1

Special charger 專用充電器 ×1

Bulletproof goggles 防彈眼鏡 ×1

CHARGE THE POWERFUL BATTERY 對動力電池充電



Connect: Press the battery plug to insert into the output socket of the charger till hear "crack".

連接：按住電池插頭插入到充電器的輸出插口中直到發出“咔嚓”一聲。

- Discharge the battery completely before charging it for the first time and the charging time is 12 hours.
- Battery charging time is about 7-8 hours, do not extra to avoid the over-charge.
- The temperature can't over 45° during charging or will damage to the battery.
- Rechargeable batteries air not to be removed from the toy before being recharged(if remove).
- Batteries are to be inserted with correct polarity.
- Exhausted batteries are to be removed from the toy.
- The supply terminals are not to be short circuited.
- 在第一次充電前，先將電池余電放淨，充電時間為12小時。
- 電池充電需要7-8個小時左右，不要超過這個時間，以免過度充電。
- 在充電過程中請注意電池溫度不得超過45度，否則將損壞電池。
- 在再充電之前，要確信電池沒有與充電器分開。
- 須按正確的極性指示安裝。
- 不能使用的電池必須立即丟棄。
- 要確信供電時沒有被短路。

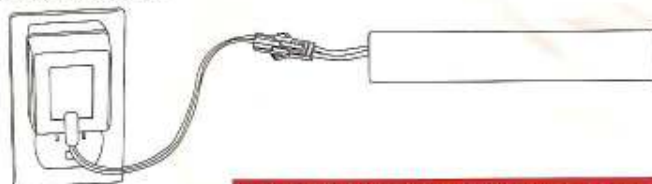

BATTERY INSTALLATION 安裝電池

ADJUSTMENT PROCEDURE 調節步驟

<p>Remove the butt plate by pressing it downwards and pull out the connector. 按下蓋板以將其取下并拔出連接器。</p>	<p>Insert the battery in the stock and connect connectors. 將電池裝入托柄裏并接上連接器。</p>	<p>When the battery and cords are set in positions, reinstall the butt plate as shown. 當電池和電纜正確安裝后，如圖所示重新裝上蓋板。</p>
--	--	--

Too much hop-up (return the lever towards NORMAL)
過度上旋 (將控制杆拔回正常位置)



Not enough hop-up (return the lever towards NORMAL)
上旋不到位 (將控制杆拔回正常位置)

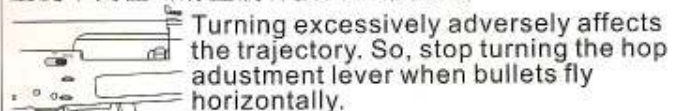

Turning excessively adversely affects the trajectory. So, stop turning the hop adjustment lever when bullets fly horizontally.
向相反方向過度旋轉會影響彈道。因此，當子彈水平射出時，停止轉動上旋調節杆。

SETTING THE MAGAZINE 裝彈匣



- 1 Press the magazine release to remove the magazine. (support the magazine as it may drop.)
按下彈匣脫扣器以拆下彈匣。(托住彈匣以免它掉下來。)

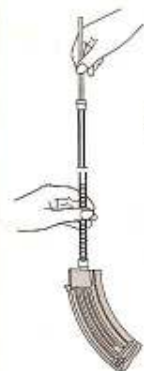

- 3 Press in bullets using the charging rod.
使用裝彈器壓緊子彈。

Caution: the magazine is capable of containing 50 rounds.
注意：彈匣可裝50發子彈。



- 4 Make sure to set the magazine upwards and connect it firmly until a click sound is heard.
確保彈匣朝上并將其牢固地連接起來直到聽到咯噠一聲。

- 2 Insert 6mm BB bullets supplied by into the charger. (42 bullets can be inserted.)
將 6mm BB子彈裝入裝彈機。(可裝入42發子彈)



REAR SIGHT ADJUSTMENTS 后瞄准器的調節

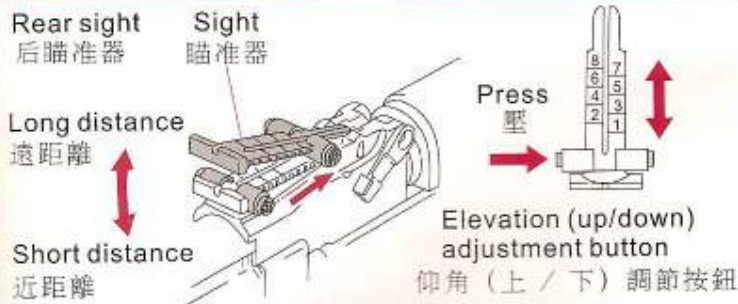

SLING INSTALLATION 安裝背帶

1. Buckle one end of the sling button on the sling ring of the rear sight, and buckle the other end on the sling ring of the gunstock.
1. 將背帶扣的一端，扣在后瞄准器的背帶環上，另一端扣在槍托背帶環上。

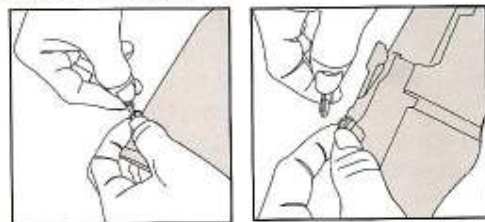

SELECTOR LEVER AND SAFETY SETTING 選擇控制杆和安全裝置



WARNING 警告:

To prevent malfunction of the switch do not change the selector lever from semi to full auto while pulling the trigger.

為防止開關發生故障，在按扳機時，不要將選擇控制杆從半自動改到全自動。

CAUTION:

Set the selector lever correctly in position; otherwise, malfunction may occur.

注意：將選擇控制杆設置在正確的位置，否則將會發生故障。

Safety setting (the trigger cannot be pulled.)

安全裝置（不能拉下扳機）
When you are not firing the gun or during storage always set the selector to the safe position.

當你不射擊或在裝子彈時，請將選擇器設置在安全位置。



Semi automatic
半自動

The gun will fire one shot each time the trigger is pulled.

每按一次扳機，氣槍將發射一發子彈。

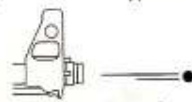
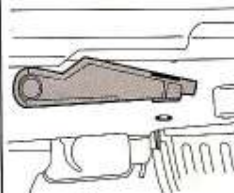

Bang!

Fully automatic
(automatic firing)
全自動（自動射擊）

The gun will fire automatically while the trigger remains pulled.

按緊扳機，氣槍將自動射擊。

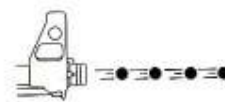
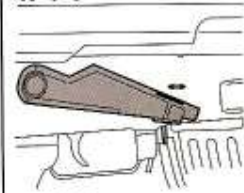

Da da da da ...

IF THE BULLET IS BLOCKED 如果子彈被卡住



Return the hop up dial to the Normal position and insert the cleaning rod from the lead edge of the barrel.

將上旋調節控制盤轉回到正常位置，並將清彈器從槍管的子彈邊緣插入。

Caution: since clogging bullets may jump out at a high speed. Always wear safety goggles and confirm safety.

注意：塞滿的子彈可能會突然快速地蹦出來，因此一定要戴護目鏡以確保安全。

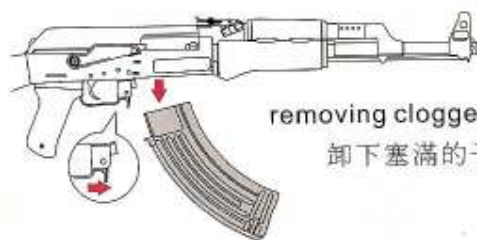

removing clogged bullets
卸下塞滿的子彈匣

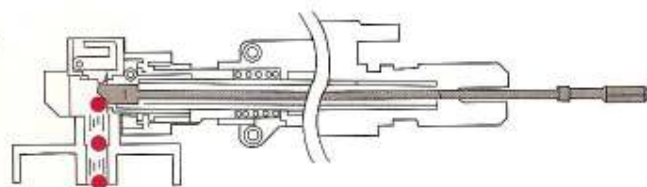

be careful so that the angled part of the cleaning rod faces down, and remove clogged bullets.
注意清彈器的尖角部分必須朝下，再取出塞滿的子彈。